

## Technical data

### 81215T2

Complete thrust bearing

Needle roller bearing, thrust cylindrical roller bearing, 812 series

#### VISUAL (S)

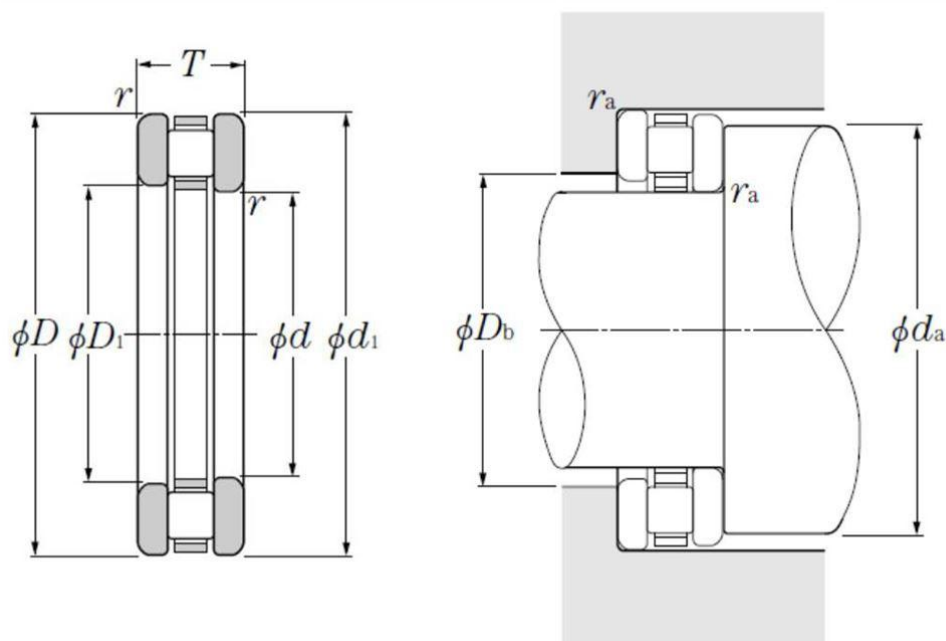

#### PRODUCT DIMENSIONS

<b>Bore diameter of support washer IR - WS (d)</b>	75.0 mm
<b>Outside diameter of support washer OR - GS (D)</b>	110.0 mm
<b>External diameter of support washer IR - WS (d1)</b>	110.0 mm
<b>Bore diameter bearing washer OR - GS (D1)</b>	77.0 mm
<b>Thrust bearing height (T)</b>	27.0 mm
<b>Roller cage bore diameter (Dc1)</b>	75.0 mm
<b>Roller cage outer diameter (Dc)</b>	110.0 mm
<b>Min fillet radius (rs)</b>	1.0 mm

### PRODUCT DIMENSIONS

<b>Cage assembly reference</b>	K81215T2
<b>Bearing ring (inner ring) WS</b>	WS81215
<b>Bearing ring (outer ring) GS</b>	GS81215
<b>Rollers reference outer diameter (Ea)</b>	103.7 mm
<b>Rollers reference inner diameter (Eb)</b>	80.1 mm
<b>Mass</b>	0.86 kg
<b>Cage assembly mass</b>	0.24 kg
<b>Bearing ring (inner ring) WS mass</b>	0.31 kg
<b>Bearing ring (outer ring) GS mass</b>	0.31 kg
<b>Brand</b>	NTN

### PRODUCT PERFORMANCE

<b>Dynamic axial load rating (Ca)</b>	138.0 kN
<b>Static axial load rating (C0a)</b>	435.0 kN
<b>Limit axial load rating (Cua)</b>	53.0 kN
<b>Nlim (grease)</b>	650.0 tr/min
<b>Nlim (oil)</b>	2600.0 tr/min
<b>Min operating temperature (Tmin)</b>	-20.0 °C
<b>Max operating temperature (Tmax)</b>	120.0 °C

### ABUTMENT

<b>Min shoulder diameter IR (da min)</b>	103.0 mm
<b>Max OR shoulder diameter (Db max)</b>	81.0 mm
<b>Max shaft &amp; housing fillet radius (ras max)</b>	1.0 mm