

Technical data

81209T2

Complete thrust bearing

Needle roller bearing, thrust cylindrical roller bearing, 812 series

VISUAL (S)

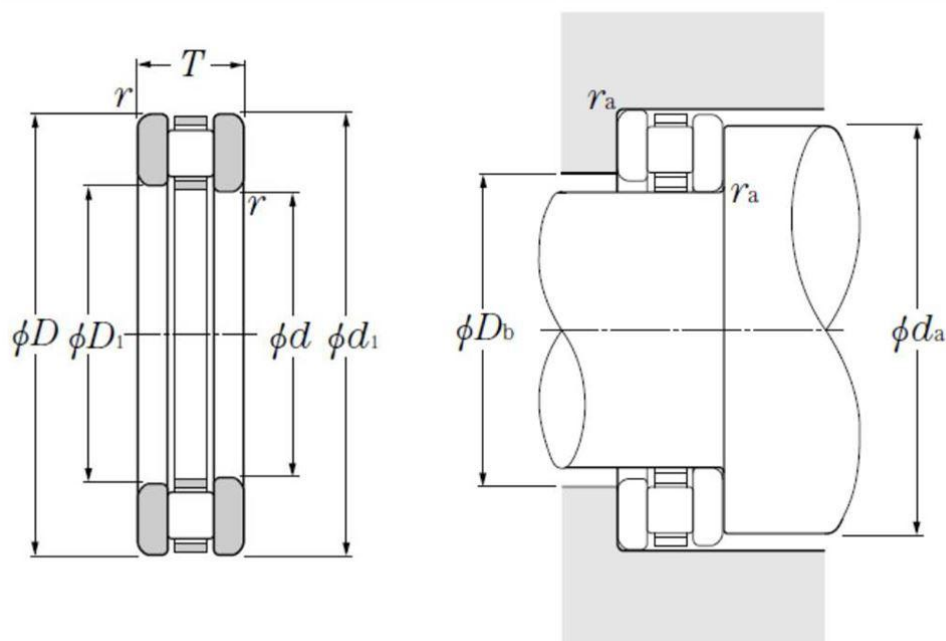

PRODUCT DIMENSIONS

Bore diameter of support washer IR - WS (d)	45.0 mm
Outside diameter of support washer OR - GS (D)	73.0 mm
External diameter of support washer IR - WS (d1)	73.0 mm
Bore diameter bearing washer OR - GS (D1)	47.0 mm
Thrust bearing height (T)	20.0 mm
Roller cage bore diameter (Dc1)	45.0 mm
Roller cage outer diameter (Dc)	73.0 mm
Min fillet radius (rs)	1.0 mm

PRODUCT DIMENSIONS

Cage assembly reference	K81209T2
Bearing ring (inner ring) WS	WS81209
Bearing ring (outer ring) GS	GS81209
Rollers reference outer diameter (Ea)	68.0 mm
Rollers reference inner diameter (Eb)	48.8 mm
Mass	0.31 kg
Cage assembly mass	0.1 kg
Bearing ring (inner ring) WS mass	0.105 kg
Bearing ring (outer ring) GS mass	0.105 kg
Brand	NTN

PRODUCT PERFORMANCE

Dynamic axial load rating (Ca)	82.0 kN
Static axial load rating (C0a)	222.0 kN
Limit axial load rating (Cua)	27.0 kN
Nlim (grease)	1000.0 tr/min
Nlim (oil)	4100.0 tr/min
Min operating temperature (Tmin)	-20.0 °C
Max operating temperature (Tmax)	120.0 °C

ABUTMENT

Min shoulder diameter IR (da min)	68.0 mm
Max OR shoulder diameter (Db max)	49.0 mm
Max shaft & housing fillet radius (ras max)	1.0 mm