

Technical data

81208T2

Complete thrust bearing

Needle roller bearing, thrust cylindrical roller bearing, 812 series

VISUAL (S)

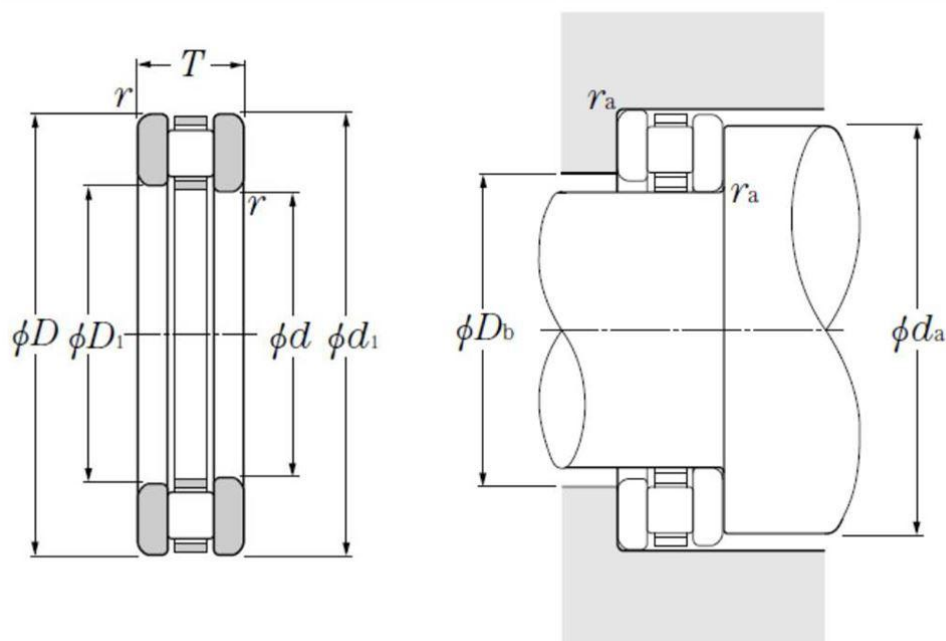

PRODUCT DIMENSIONS

Bore diameter of support washer IR - WS (d)	40.0 mm
Outside diameter of support washer OR - GS (D)	68.0 mm
External diameter of support washer IR - WS (d1)	68.0 mm
Bore diameter bearing washer OR - GS (D1)	42.0 mm
Thrust bearing height (T)	19.0 mm
Roller cage bore diameter (Dc1)	40.0 mm
Roller cage outer diameter (Dc)	68.0 mm
Min fillet radius (rs)	1.0 mm

PRODUCT DIMENSIONS

Cage assembly reference	K81208T2
Bearing ring (inner ring) WS	WS81208
Bearing ring (outer ring) GS	GS81208
Rollers reference outer diameter (Ea)	62.9 mm
Rollers reference inner diameter (Eb)	43.7 mm
Mass	0.265 kg
Cage assembly mass	0.085 kg
Bearing ring (inner ring) WS mass	0.09 kg
Bearing ring (outer ring) GS mass	0.09 kg
Brand	NTN

PRODUCT PERFORMANCE

Dynamic axial load rating (Ca)	74.5 kN
Static axial load rating (C0a)	190.0 kN
Limit axial load rating (Cua)	23.2 kN
Nlim (grease)	1100.0 tr/min
Nlim (oil)	4400.0 tr/min
Min operating temperature (Tmin)	-20.0 °C
Max operating temperature (Tmax)	120.0 °C

ABUTMENT

Min shoulder diameter IR (da min)	63.0 mm
Max OR shoulder diameter (Db max)	44.0 mm
Max shaft & housing fillet radius (ras max)	1.0 mm