

## Technical data

### 81206T2

Complete thrust bearing

Needle roller bearing, thrust cylindrical roller bearing, 812 series

#### VISUAL (S)

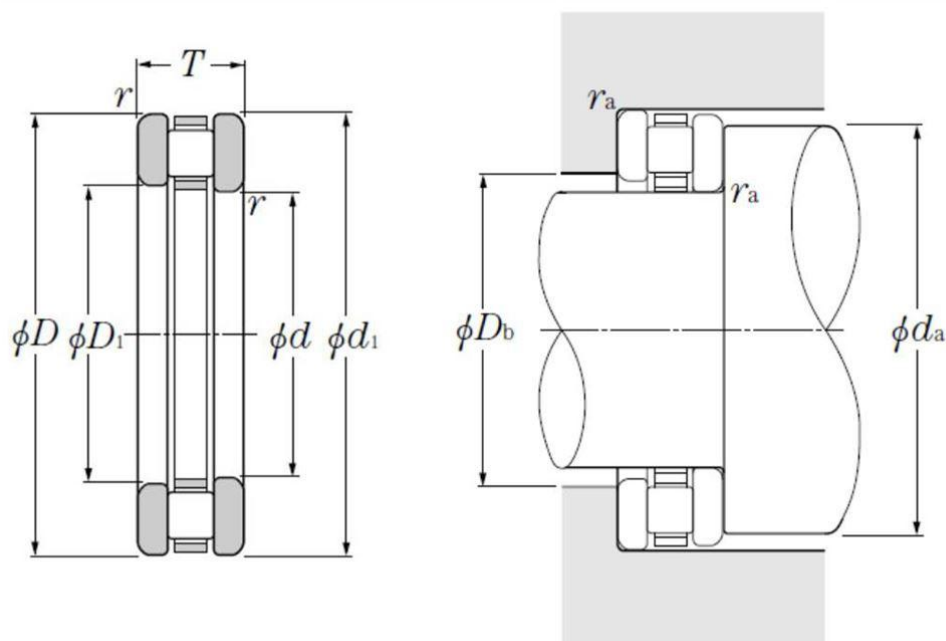

#### PRODUCT DIMENSIONS

<b>Bore diameter of support washer IR - WS (d)</b>	30.0 mm
<b>Outside diameter of support washer OR - GS (D)</b>	52.0 mm
<b>External diameter of support washer IR - WS (d1)</b>	52.0 mm
<b>Bore diameter bearing washer OR - GS (D1)</b>	32.0 mm
<b>Thrust bearing height (T)</b>	16.0 mm
<b>Roller cage bore diameter (Dc1)</b>	30.0 mm
<b>Roller cage outer diameter (Dc)</b>	52.0 mm
<b>Min fillet radius (rs)</b>	0.6 mm

PRODUCT DIMENSIONS	
Cage assembly reference	K81206T2
Bearing ring (inner ring) WS	WS81206
Bearing ring (outer ring) GS	GS81206
Rollers reference outer diameter (Ea)	49.0 mm
Rollers reference inner diameter (Eb)	32.8 mm
Mass	0.14 kg
Cage assembly mass	0.05 kg
Bearing ring (inner ring) WS mass	0.045 kg
Bearing ring (outer ring) GS mass	0.045 kg
Brand	NTN

PRODUCT PERFORMANCE	
Dynamic axial load rating (Ca)	53.0 kN
Static axial load rating (C0a)	129.0 kN
Limit axial load rating (Cua)	15.7 kN
Nlim (grease)	1500.0 tr/min
Nlim (oil)	6000.0 tr/min
Min operating temperature (Tmin)	-20.0 °C
Max operating temperature (Tmax)	120.0 °C

ABUTMENT	
Min shoulder diameter IR (da min)	48.0 mm
Max OR shoulder diameter (Db max)	33.0 mm
Max shaft & housing fillet radius (ras max)	0.6 mm